

Data Sheet



Article number: 20302341

Description: E+G Handwheel
DIN 950-AL-250-B22-A

Measures

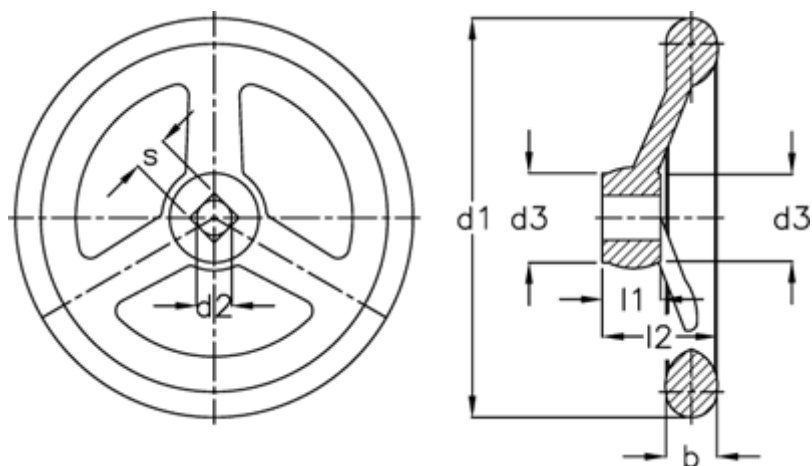

b	= 26
d1	= 250
d2 H7	= 22
d3	= 45
l1	= 28
l2	= 50
Number of spokes	= 5